

## Quick Start Guide

This document provides installation steps to rack, cable, and power on a US424 Storage Expansion. For additional documentation please visit <https://www.nexsan.com/support/support-unity/>

### Taking delivery

Check to ensure that no damage has been sustained to the packaging in transit. If any of the US424 Storage Expansion components appear damaged, please contact your reseller immediately.

### Hardware overview

The main components of the US424 Storage Expansion are shown in these diagrams:

Front view (bezel removed)

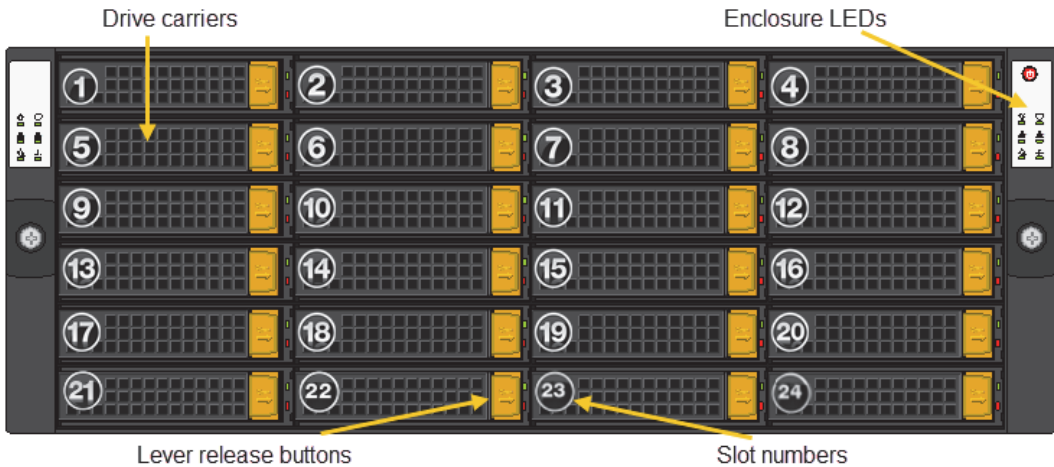

Rear view IO controller

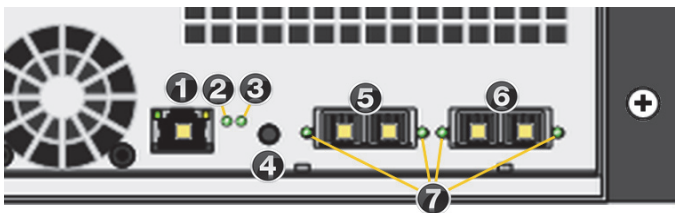

Item	Name	Description
1	LAN Port (not used)	Not used
2	Storage unit status LED	Green: Initialization successful Red: Initialization failure
3	Unit ID status LED	On/Off
4	BMC Reset button	Resets the base management controller
5	SAS IN ports	Serial Attached SCSI IN ports from the storage system
6	SAS OUT ports	SAS OUT ports to another storage enclosure
7	SAS link status LEDs (2 IN, 2x OUT)	Green: All four physical layers (PHY) of each port connected with consistent link speed (12G or 6G) Red: Single PHY degraded link speed or disconnected

D Arrange for someone to assist you during installation.

## 1 Prepare for installation

- A Carefully read safety notices on [page 4](#).
- B Ensure ahead of time that you have a suitable rack; see [Rack and enclosure specifications on page 4](#).
- C Ensure that you have a Phillips screwdriver.



**CAUTION:** Acclimate new disk drives to room temperature for two hours before you install them.

## 2 Unpack the US424 Expansion

- A Remove all the components from the packaging. Position hands under the chassis to pull it free from the foam insert. Do NOT lift out the US424 chassis from its packaging using the controller handles or attached rails.
- B Place the components on an anti-static surface until you are ready to use them.

### US424 Expansion package contents

- One US424 expansion and front bezel
- Rack-mounting hardware:
  - Two outer-rack rail assemblies (inner-chassis rails are already installed)
  - Four mounting screws with 4 washers to attach outer-rack rails to the rack (1 on the front and 1 on the back for both the left and right rail assemblies)
- FASTier, SSD, and HDD drives. Check that the components included in your shipment correspond to your packing slip.
- SAS cables (HD Mini SAS to HD Mini SAS)
- Two power cords
- One electrostatic discharge (ESD) wrist strap

## 3 Rack the US424 Expansion

 **CAUTION:** Physical installation requires two people.

### ► Step 1: Remove the front bezel

- A Turn the key lock at the right end of the bezel to the unlock position.
- B Unhook the left end of the bezel from the chassis.

### ► Step 2: Install the outer-rack rails on the rack

- A Attach the **RIGHT** and **LEFT** outer-rack rails to the rack by inserting the hooks included on the rails into the holes provided on the rack. The hooks should be located in the **TOP** holes of the rack units selected.
- B Extend rail assemblies to fit the depth of the rack. Pull on the rear of the assembly until the hooks reach the back of the rack.
- C Screw the rail to the rack using the mounting screws provided. The screws should be secured in the **BOTTOM** hole on the front and back of each rail assembly.

### ► Step 3: Install the inner rails on the chassis (if necessary)

- A Extend the inner rail toward the front of the rail assembly as far as possible, then depress the locking tab to pull it completely out.
- B Place the inner rail on the side of the chassis, aligning the hooks of the chassis with the rail extension holes.
- C Slide the extension toward the front of the chassis.
- D If desired, secure the chassis with screws.
- E Repeat steps A-D for the other inner rail.

### ► Step 4: Install the US424 Expansion on the rack

- A Lift the US424 chassis from each side—not from the front and back.
- B Line up the inner-chassis rails with the front of the outer-rack rails.
- C Slide the inner-chassis rails into the outer-rack rails, keeping the pressure even on both sides; you have to depress the locking tabs when inserting.
- D Push the US424 Expansion fully into the rack; you should hear the locking tabs click into position.
- E Tighten the thumbscrews that hold the front of the US424 Expansion to the rack.

### ► Step 5: Install the data drives



**CAUTION:** Put on the ESD wrist strap before starting:

- A Slip the wrist loop over your hand (left or right), then tighten the loop against your wrist.
- B Attach the clip end of the anti-static wrist strap to a properly grounded metal surface.

### Installation order:

- A Install the FASTier SSDs in the slot as indicated on the label on the drive.
- B Install the disk drives in any order in the remaining slots.

The half-populated drive configuration includes empty drive carriers for expansion.

### To install the drives:

- A Slide the release button on the front of the drive carrier and open the handle.
- B Insert the hard-drive carrier into the drive bay until the carrier contacts the backplane.
- C Close the hard-drive carrier handle to lock the drive in place.
- D Repeat these steps for each drive.



### Install the Nexsan Unity Storage System

Unpack and install any Nexsan Unity Storage Systems (such as the UNITY4400 or UNITY6900) included in your Unity shipment.

For detailed instructions, refer to the appropriate *Nexsan Unity Quick Start Guide* included in the packaging.

## 4 Connect to the Unity Storage System

This section describes the steps for connecting the power, and for connecting the US224 to a Unity Storage System.

### ► Step 1: Cross-connect the US424 Expansion to the Unity Storage System

- A Cross-connect from the add-on SAS OUT ports on each storage system controller to the on-board SAS IN ports on the storage expansion controllers, as shown in on [page 3](#).

- B** Connect any additional storage expansions using the daisy chain method, also as shown.



**CAUTION:** Do not connect to the Unity Storage Expansion from the on-board SAS ports on either the UNITY4400 or the UNITY6900.

## ► Step 2: Connect the power cables

- A** Plug the power cords into their respective power supplies on the rear of the US424 Expansion.

- B** Plug the power cords connected to the power supply units into a high-quality strip that offers protection from electrical noise and power surges.

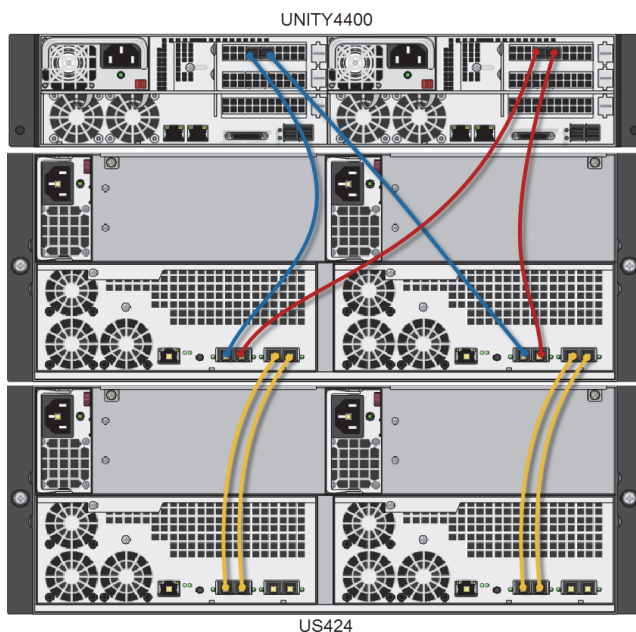

**CAUTION:** Use only the supplied power cords. Do not use another type of cord or extension cords. If you require additional power cords, please contact your Nexsan sales representative.

**NOTE:** We strongly recommend that you use an uninterruptible power supply (UPS).

- C** Turn the key lock at the right end of the bezel to the lock position to secure the bezel to the chassis.

## 5 Power on the US424 Expansion

The US424 Storage Expansion and Unity Storage Systems are hot-pluggable. Once in service, powering down is not normally required to add a Unity Storage Expansion.

### ► Step 1: Power on the US424

- A** Power on the US424 Expansion by pressing and holding the power button located on the right front panel of the chassis until the power LED lights up.
- B** Wait approximately 1 minute for the drives to all initialize.
- C** Verify that all drive carrier activity LEDs are illuminated in green. If a drive carrier activity LED does not light up, check to make sure that the corresponding drive is properly seated in the chassis.

### ► Step 2: Reattach the front bezel

If all LEDs indicate normal operational status, reattach the front bezel to the US424 Expansion:

- A** Hook the left end of the bezel onto the chassis.
- B** Fit the right side of the bezel onto the chassis.

## 6 Monitor the US424 Expansion







This section describes the front panel LEDs that help you to monitor the US424 Storage Expansion.

### Control Panel LEDs

The two control panels located on the front left and right sides of the US424 Expansion have several LEDs. These LEDs provide you with critical information related to the corresponding node. If the Power fail or Fan fail LED illuminates, replace the component as described in the *Nexsan Unity Storage Expansion Reference Guide*.

### Drive Carrier LEDs

Each drive carrier on the US424 Expansion has two LEDs. If a drive fails, replace the drive as described in the *Nexsan Unity Storage Expansion Reference Guide*.

LED	Indication
	<p><b>Power</b></p> <p>Indicates power is being supplied to the system's power supply units. This LED is illuminated when the system is operating.</p>
	<p><b>Heartbeat</b></p> <p>This is a server board heartbeat LED and indicates that power is being supplied to the server board.</p>
	<p><b>NIC1</b></p> <p>Indicates network activity on the LAN1 port when flashing.</p>
	<p><b>NIC2</b></p> <p>Indicates network activity on the LAN2 port when flashing.</p>
	<p><b>Power fail</b></p> <p>Indicates a power supply module has failed. The second power supply module takes the load and keeps the system running, but the failed module should be replaced as soon as possible.</p> <p>This LED should be off when the system is operating normally.</p>
	<p><b>Fan fail</b></p> <p>When flashing, this LED indicates a fan failure.</p> <p>When illuminated continuously, this LED indicates overheating, which may be caused by cables obstructing the airflow in the system or the room temperature being too high.</p> <p>Check the routing of the cables and make sure all fans are connected and operating normally. You should also check to make sure that the chassis covers are installed.</p>

Drive LED	Indication
Green	<ul style="list-style-type: none"> <li>A steady green LED indicates the drive is powered on.</li> <li>If this LED is not lit, the drive is not getting power.</li> <li>If this LED is flashing, the drive is being accessed (read or write).</li> </ul>

Drive LED	Indication
Red	<ul style="list-style-type: none"> <li>A steady red LED indicates a drive failure.</li> </ul>

### Safety notices

- This equipment must be installed and operated in compliance with local laws and regulations.
- Ensure that the ambient temperature at the installation site is between 5°C (41°F) and 30°C (86°F). If the temperature at the site is not actively regulated, ensure that daily and seasonal temperature changes will not result in the ambient temperature going outside these limits.
- Always fully stabilize racks with wall anchors or stabilizing legs, or both, before mounting the Nexsan storage expansion or any other components on the rack.
- Situate the rack so that full air flow at both the front and the rear of the Nexsan storage expansion is possible.
- Ensure that the floor beneath the mounting rack has enough load-bearing capacity to support the rack and all mounted components.
- Always fully secure all rack-mounting hardware when installing the Nexsan storage expansion in a rack. Insufficient rack-mount support may allow the unit to fall onto other rack-mounted hardware or onto the floor, potentially damaging equipment or causing injury.

### Rack and enclosure specifications

#### Rail kit mounting

- 4U enclosure height
- The rack has square holes
- Maximum distances: 30" (800 mm)

#### Enclosure dimensions

- Height: 7" 178 mm
- Width: 17.2" 437 mm
- Depth: 27" 686 mm
- Weight: 27" 686 mm

#### Weight

- 60.5 lbs 27.4 kg (no drives installed)
- 81 lbs 36.7 kg (all drives installed)

#### Power requirements

- Power supply: 1600W
- Input voltage: 100-240V; Input frequency: 50/60 Hz
- Amperage: 12V (100A @ 240V), +5Vsb (6A @ 240V, 4A @ 100V)
- Power consumption: Varies, depending on the number and size of drives, running fans, and room temperature



Part number: P0450171 Rev: F Release Date: August 2019  
 Related Documentation: Nexsan Unity Hardware Maintenance Guide, Nexsan Unity User Guide, Nexsan Unity Online Help, Nexsan Unity nxadmin CLI Reference Guide

#### Technical Support

By Email: [support@nexsan.com](mailto:support@nexsan.com)  
 By Web: <https://www.nexsan.com/support/support-unity/>