

NEXSAN Unity Storage U2G460 Expansion

Quick Start Guide

This document provides installation steps for racking and cabling the Unity Storage U2G460 Expansion, and for connecting to a Unity Storage System. Instructions are also provided for powering on and monitoring. For the latest updates, please visit <https://www.nexsan.com/support/support-unity/>

Taking delivery

Check to ensure that no damage has been sustained to the packaging in transit. If any of the Unity storage components appear damaged, you should file a damage claim with your reseller.

Hardware overview

The front, top, and rear views of the U2G460 are shown in these diagrams.



- 1 Power supply units and fan assemblies
- 2 Primary fan assemblies
- 3 LEDs. See *Monitor the Unity Storage Expansion* on page 7
- 4 I/O module (IOM) ports: 6 HD Mini-SAS ports. See *Connect to a Unity Storage System* on page 6
- 5 Management ports

1 Prepare for installation

- A Carefully read safety notices on *page 8*.
- B Ensure ahead of time that you have a suitable rack; see *Rack and enclosure specifications* on *page 8*.
- C Ensure that you have a Phillips screwdriver.
- D Arrange for assistance to unpack and move the U2G460 Storage Expansion into position. The unit weighs 84 lbs without drives and 175 lbs fully populated (see *page 8*).



CAUTION: Acclimate new disk drives to room temperature for two hours before you install them.

2 Unpack the U2G460

- A** Remove all the components from the packaging. Use the black lifting straps to remove the U2G460 chassis from its packaging.
- B** Place the components on an anti-static surface until you are ready to use them.

U2G460 package contents

Shipments typically include the following items:

- One U2G460 expansion (with front bezel), supporting up to 60 3.5" drives, or 2.5" drives with adapters
- Accessory tray:
 - 2 top cover guide brackets
 - 10 cage nuts
 - 30 M5 x 12, T15 Torx screws, 2 M5 x 12 Philips panhead screws (for the cover), 4 custom, low-profile M4 screws (packaged with the rail kit)
 - 16 custom round washers to attach outer-rack rails to the rack (1 on the front and 1 on the back for both the left and right rail assemblies)
- Up to 3 drive packs. Drive packs consist of 1 SSD and 19 DATA HDDs. Up to 3 drive packs can be used in a U2G460. Check that the drives included in your shipment correspond to your order and packing slip.
- Rails box - 2 rack rails with 1 inner rail per rack rail.
- Chassis with all internal components pre-installed, except disk drives.
- Drive blanks to fill empty slots, if applicable
- MiniSAS HD passive SAS cables
- Optional MiniSAS HD active cables
- Two C13 to C14 power cables (3m)



CAUTION: To avoid possible data issues, disconnects, or damage, use cables that can extend the length of the U2G460 when the drawer is pulled open (maximum 4 m).

- Optionally, two cable management arms (CMAs)
- 1 electrostatic discharge (ESD) wrist strap

3 Rack the U2G460



CAUTION: Physical installation requires three people--two to move the enclosure into position in the rack, and one to guide and spot the others.

Example rack positions for components:

- Unity 3300 or Unity 7900 (top) Storage System
- U2G460 (bottom) below the storage system

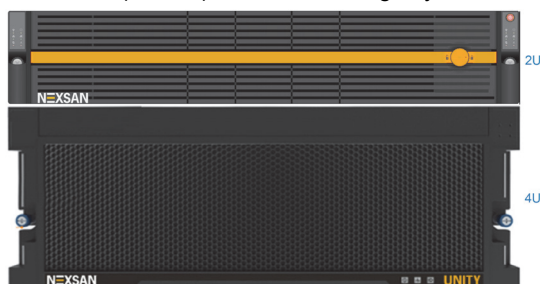

Step 1: Install the outer-rack rails on the rack

- A** From the inside of the rail kit, press the release latch to unlock the inner rails from the rack mount rails. Pull the inner rail out of the rack mount rail, and repeat for the remaining rail.

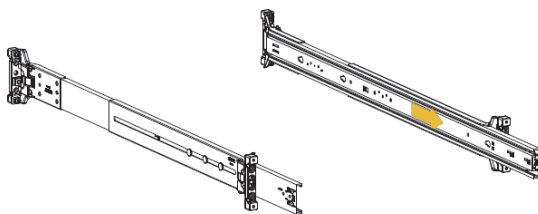

- B** Attach the outer rails to the rack. Pay special attention to which side is being installed. The embossed R is for the right side and L is for the left side. Right and Left refer to when you are facing the front of the rack.
 - a** Move to the rear of the rack.
 - b** Orient the rail so that the word "REAR" embossed on the rail is at the rear end of the rack, and the release button is facing the inside of the rack posts as shown in the following image.

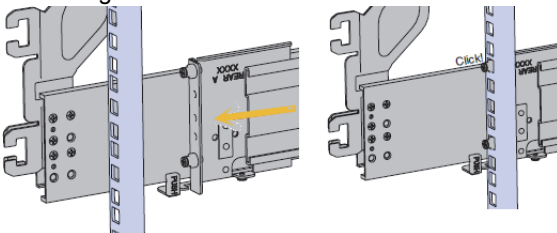

- c** Align the rail on the rack posts at the U-height desired for installation. The bottom of the rail will be the lower most U of the total 4U height.
- d** Pull the rail toward the rack post until the toolless latching mechanism engages the rack. The toolless latching mechanism may need to be pulled open to get around the rack post.
- e** Move to the front of the rack.
- f** Align the front of the rail with the holes on the rack posts that will receive the rails and pull the rail toward the holes until the toolless latching mechanism engages the rack.

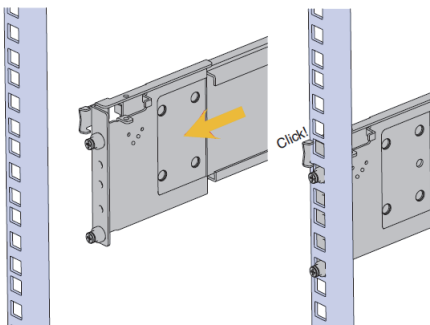

- g** Use a level to make sure that the rails are aligned properly.
- h** Follow these steps for the other outer rail.

► Step 2: Install the inner rails on the chassis

- A Attach left and right inner rails (viewing from the front) by aligning the keyholes on the inner rail with the mounting pegs on the side of the chassis and sliding them forward to lock them in place. Left and right are embossed with the letter “L” and “R” on the side facing away from the chassis.
- B From the side of the chassis, using the #2 Phillips-head screwdriver, attach the inner rails to the chassis using the screws provided with the rail kit.



CAUTION: When installing the inner rail onto the chassis, make sure to only use the special low-profile M4 x 3.2mm Philips screws provided in the accessory kit with the CMA. These screws should be tightened to 8-10 in-lbf using a # 2 Philips screwdriver. These screws are specially designed for this purpose. Using unapproved screws could cause damage to the slides inside the rail.

- C Slide the inner rail toward the rear of the chassis to lock it into place.
- D Repeat the previous steps to attach the other inner rail to the chassis.

► Step 3: Secure the cable tray (if necessary)

- A Secure the cable tray onto the enclosure using the included M3 x 8mm T10 Torx screws and the long T10 Torx screwdriver. These screws should be tightened to 3-5 in-lbf.

NOTE: The cable tray only needs to be installed if the number of cables being used is greater than 10. If not, this step is unnecessary.

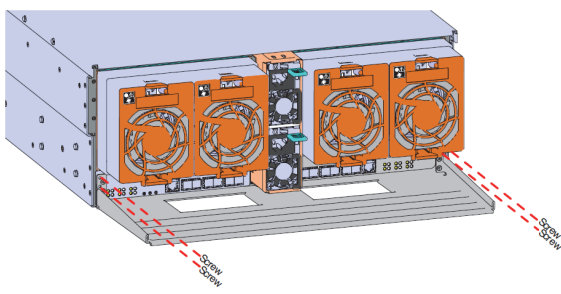

CAUTION: To avoid possible tipping of the rack, install the U2G460 as low as possible. Each fully loaded enclosure weighs 175 lbs.

- B Install one cage nut at the uppermost mounting hole of the 4U space that the enclosure will occupy.
- C If the U2G460 will be installed in a rack for shipping purposes, install four more cage nuts in holes 3-6 of the 4U space. These will receive the M5 x 10mm T15 Torx screws that secure the enclosure to the rack with the shipping bracket. These screws should be tightened to 30-32 in-lbf using a long T15 Torx screwdriver.
- D Install the rear cover alignment brackets.
 - a From the rear of the rack, orient the alignment brackets so that the groove that will catch the lid is facing the inside of the rack.

- b Use five of the M5 x 10mm T15 Torx screws and 5 of the included washers and attach the rear cover alignment bracket to the vertical rail with the Long T15 Torx Screwdriver. Add three M5 x 10mm T15 Torx screws and three included washers to attach the rear rail to the rack posts as shown in the following image. These screws should be tightened to 30-32 in-lbf using a Long T15 Torx Screwdriver.

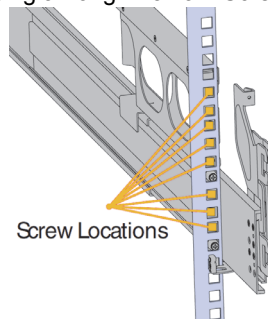

► Step 3: Install the cable management arms (if necessary)

NOTE: If you are using a storage enclosure with a shorter depth you may not be able to use CMAs. Ensure that the CMAs do not bind or bend. Improper installations could result in damage to cabling and components.

- A Install the upper CMA, orienting the elbow on the right hand side.
- B Align the crossbar with the mounting peg facing down and pointing toward the CMA mounting bracket.

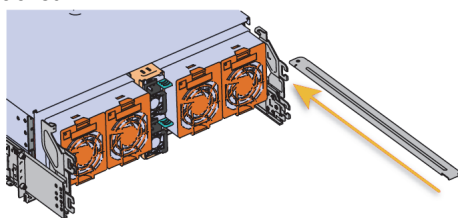

- C Insert the peg on the underside of the crossbar into the slot on the CMA mounting bracket.

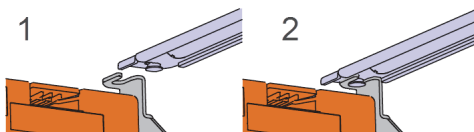

- D Swing the crossbar so that the thumbscrew lines up with the mounting hole on the opposite side of the enclosure.

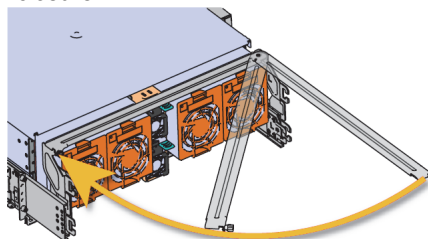

- E Press the crossbar against the CMA mounting bracket and secure the crossbar in place by pressing and turning the thumbscrew clockwise until snug.
- F Install the lower CMA arm, orienting the elbow on the left side.

- G** Attach all of the connectors to the brackets on the rails and chassis. There should be one at the elbow side and two at the other end.

Lower CMA orientation

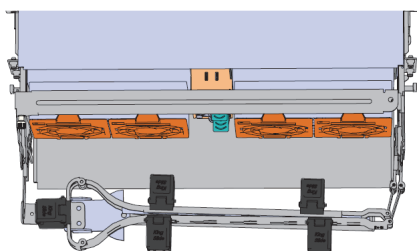

- H** Slowly slide the enclosure forward to ensure the CMA arm is operating properly, then slide it back into the rack.
- I** Mirror the steps above to install the lower cable management arm.

► **Step 4: Thread the cables through the CMAs**

NOTE: Before cabling the CMAs, note the following routing of the cables. For best results, the cables that are supported by the upper CMA are inserted into IOM B (right hand side looking at the rear) and the lower CMA cables are routed to IOM A (left hand side looking at the rear)

Thread the cables into the CMAs, beginning with the lower CMA.

- A** Unlatch the elbow side of the CMA arm and swing it forward by pressing the blue button that says “push” to unlatch it.
- B** Gather the SAS cables, one power cable, and one Ethernet cable to install in the left hand side. For each cable, reserve enough slack at the connector end to operate smoothly. Allow 20" - 21" (508 – 533.4mm) between the end of the connector and the first basket. Make sure to route all of the upper CMA cables under the lower CMA cables.
- C** Test for binding in the extension of the CMAs by gently pulling the enclosure out of the rack to ensure the cables extend properly and that the system doesn't bind. Adjust the lengths as necessary.

► **Step 5: Install the U2G460 on the rack**



CAUTION: This step in the installation requires a minimum of 3 individuals to install safely, two to lift and one to guide the others whom may have difficulty seeing because the enclosure is in the way. Ensure that the appropriate measures are taken to safely support the enclosure during installation. The enclosure **MUST** have no drives installed and requires a two person team lift to install. Do not attempt to lift the system if it is fully populated with drives.



CAUTION: The handles on the front of the chassis are not intended to be used to support the weight of the Ultrastar Data60. Lifting the unit by the chassis handles or trying to support the unit on the handles can cause them to fail. This can cause serious damage to the unit or serious bodily harm to those handling the unit. Always team lift the chassis by gripping the underside of the unit, and never try to lift a chassis that is filled with drives.



WARNING: Do not lift the chassis by the cable tray while removing the chassis from the rack OR while installing it into a rack. This can cause serious damage to the storage expansion or serious bodily harm to those handling it.

Always team lift the chassis by gripping the underside of the unit, and never try to lift a chassis that is filled with drives.

- A** Extend the mid-rails out of the rack so that they are protruding from the front of the rack and the safety latches engage.

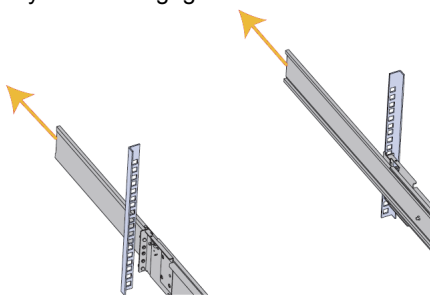

CAUTION: To prevent potential damage due to improper mating of the rails, make sure that the bearing plates on the inside of the mid-rails are fully forward and that the lock has engaged.

- B** Team lift the U2G460 chassis from the sides—not from the front and back.
- C** Line up the inner-chassis rails with the extended rack rails, until the rail locks engage.
- D** Locate the blue tabs on each of the inner rails, and slide them towards the front of the chassis. Push on the chassis, pushing the U2G460 completely into the rack; you should hear the locking tabs click into position.

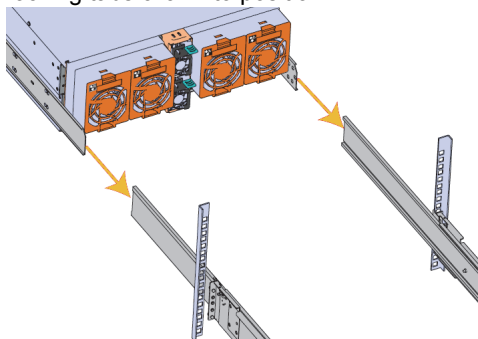

- E** Tighten the thumbscrews that hold the front of the U2G460 to the rack.

Step 6: Install the disk drives and FASTier read cache SSDs



CAUTION: Put on the ESD wrist strap before starting:

- A** Slip the wrist loop over your hand (left or right), then tighten the loop against your wrist.
- B** Attach the clip end of the anti-static wrist strap to a properly grounded metal surface.

The enclosure does not support a mix of SAS and SATA drives.

FASTier Read Cache is installed in the Unity 3300 or Unity 7900 system:

A Remove the front bezel from the Unity 3300 or Unity 7900

B Install the FASTier Read Cache starting from the left slot in the Unity 3300 or Unity 7900

The number of FASTier Read Cache is based on the number of HDD drives installed.

20 HDD Drive = 1 FASTier SSD
40 HDD Drive = 2 FASTier SSDs
60 HDD Drive = 3 FASTier SSDs

Drive installation order:

To ensure proper air flow, install the drives as explained below. The enclosure does not support a mix of SAS and SATA drives. Any unfinished rows must be completed with drive blanks.

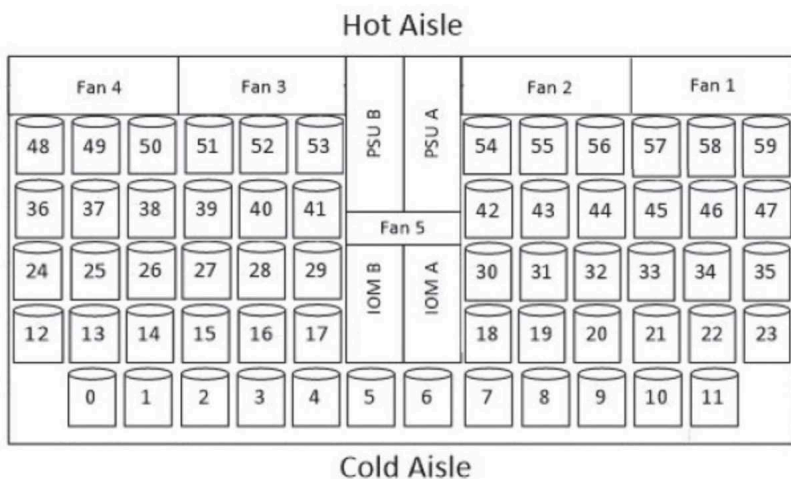

- C** Install the drives closest to the power supplies at the rear of the enclosure, moving forward one row at a time.



CAUTION: If the U2G460 is not fully populated, to maintain proper air flow you **MUST** install drive blanks to complete the last incomplete row of drives.

To install the drives:

- A** Slide the expansion out of the rack, by pulling on the front handles.
- B** Slide the expansion cover back to show the drive bays.
- C** Align the drive with the empty slot that will receive it. Lower it into the slot, making sure it stays level and does not snag.

- D** Pinch the latch release and carefully press downward to seat the drive assembly the rest of the way.



- E** Repeat these steps for each drive, following the drive layout shown above.

NOTE: If you have empty drive bays in a row of 12, you must include blank drive spacers to ensure proper airflow to the working drives.

If you add drives of a different size to an existing system, you must reconfigure RAID for the new disks. Refer to the Nexsan Unity Online Help.

4 Install the Unity Storage System

Unpack and install any Unity Storage System included in your Unity shipment. The U2G460 can be used with either a Unity 3300, or a Unity 7900.

For detailed instructions, refer to the appropriate *Nexsan Unity Quick Start Guide* and the *Nexsan Unity Storage Expansion Reference Guide* at www.nexsan.com/ (see Support > Unity > Documentation & Online Help).

5

Connect to a Unity Storage System

Connect one or more U2G460 expansions to a Unity Storage System and power them on.

► Step 1: Connect to the U2G460:

- Cross-connect from the Add-on HBA SAS OUT ports on the Unity Storage System to the HBA SAS IN ports on the first U2G460, as shown in

Unity 3300 connected to U2G460 expansions, below.

You can cascade other types of Nexsan storage expansions with the U2G460, but the U2G460 units must be connected last in the series.

For details about connections and about cascading to more Unity Storage Expansions, please see the *Nexsan Unity Storage Expansion Reference Guide* at www.nexsan.com.



CAUTION: Do not connect to the Unity Storage Expansion from the lower, on-board SAS ports on the Unity 3300 or the Unity 7900.

Use cables that can extend the length of the U2G460 when the drawer is pulled open.

Use up to 3m SAS cables to connect between the Unity Storage System and U2G460. Passive SAS cables should only be used when connecting the first U2G460 to the Unity Storage System. Active SAS cables are required to daisy chain between U2G460s.

The Unity Storage System is hot pluggable: Once in service, powering down is not normally required to add a Unity Storage Expansion. It is recommended to plug in the power cables to power on the new U2G460 last.

Unity 3300 connected to U2G460 expansions

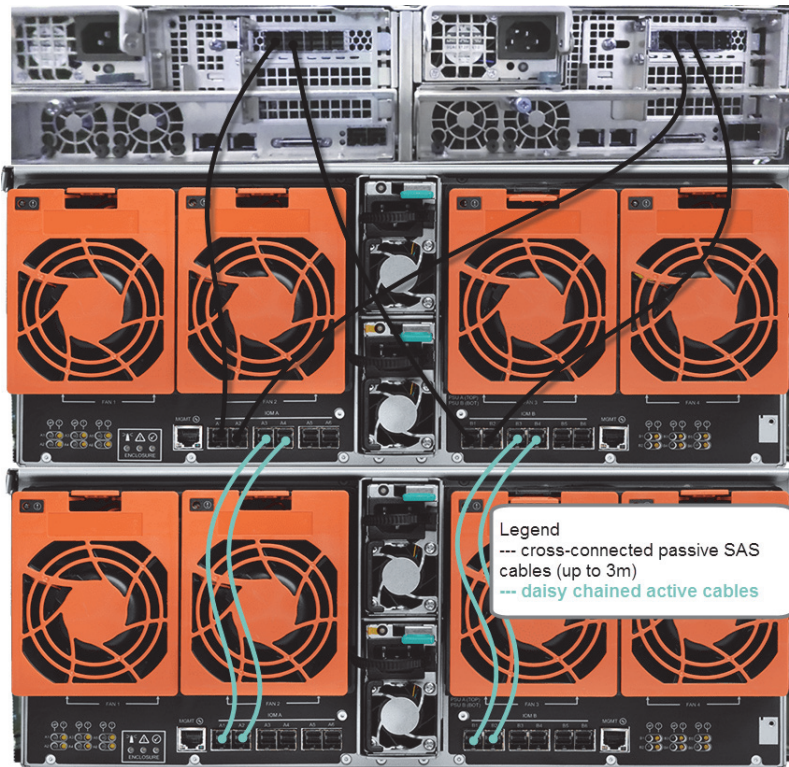

► Step 2: Connect the power cables



CAUTION: Use only the power cords supplied with the U2G460. Do not use another type of cord or extension cords. If you require additional power cords, please contact your Nexsan sales representative or reseller.

- Plug the power cords into their respective power supplies on the rear of the U2G460.
- Plug the power cords connected to the power supply units into a high-quality strip that offers protection from electrical noise and power surges.

NOTE: We strongly recommend that you use an uninterruptible power supply (UPS).

6 Power on Unity components



Power on the Unity components for the first time in the sequence described in this section.

Step 1: Power on the U2G460

A Plug in the power cables on the back of the U2G460. The U2G460 will power on automatically.

NOTE: If you are adding multiple Unity Storage Expansions, power them on from last to first.

Step 2: Power on the Unity Storage System

Power on the Unity Storage System; either the Nexsan Unity 3300 or the Nexsan Unity 7900. If a drive carrier activity LED does not light up, check to make sure the corresponding drive is properly seated in the chassis.

A Press and hold the power button located on the right front panel of the chassis until the power led lights up.

B Verify that the power LEDs  on the left and right front control panels are illuminated to ensure that the controller nodes are receiving power and the power modules are functioning properly.

C Verify that the heartbeat  is blinking yellow in 2-3 second intervals.

D Verify that the drive carriers LEDs are illuminated in green.

E If all LEDs indicate normal operational status, reattach the front bezel to the Unity 3300 or Unity 7900:

- Remove the bezel from its packaging.
- Hook the left end of the bezel onto the chassis.
- Fit the free end of the bezel onto the chassis.
- Turn the key lock at the right end of the bezel to the lock position to secure the bezel to the chassis.

7 Monitor the Unity Storage Expansion

This section describes the front and back panel LEDs that help you monitor the Nexsan Unity U2G460 Storage Expansion.

Rear I/O LEDs

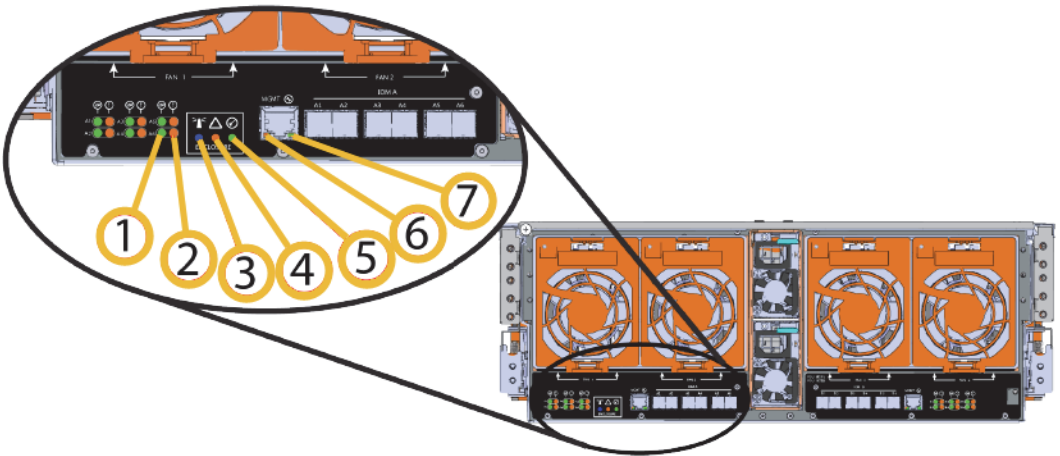

Number	Color	LED name	Description
1	Green	SAS link status	Solid – SAS Cable Connected Off – SAS Cable Not Connected
2	Amber	SAS fault status	Blink @ 1 Hz – SAS connection fault Off – No SAS connection fault
3	Blue	Identification	Blink @ 1 Hz – Blinks only when Identification has been activated. Will blink when any component is identified.
4	Amber	Fault	Blink @ 1 Hz –Enclosure has a fault Off – Enclosure has no fault
5	Green	Power	Solid - Powered On
6	Green/Amber	Ethernet connectors link/activity	Off - Operating at 10 Mbps Green Solid - Operating at 100 Mbps Amber Solid - Operating at 1Gbps
7	Green	Ethernet connector	Off - No Connection Solid - Connected Blink - Activity

The U2G460 storage expansion has the following LEDs on the front of the enclosure:



Number	Color	LED name	Description
1	Blue	Identify	Blink @ 1 Hz – Blinks only when Identification has been activated. Will blink when any component is identified.
2	Amber	Fault	Blink @ 1 Hz –Enclosure has a fault Off – Enclosure has no fault
3	Green	Power	Solid - Powered On

The U2G460 I/O modules (IOMs) have the following LEDs:

Color	Name	Description
Blue	Identify	Blink @ 1 Hz – Blinks only when Identification has been activated. Will blink when any component is identified.
Amber	Fault	Blink @ 1 Hz –Enclosure has a fault Off – Enclosure has no fault
Green	Power	Solid - Powered On

Each drive carrier has two LEDs. If a drive fails, replace the drive as described above. See *Step 6: Install the disk drives and FASTier read cache SSDs*

Safety notices

- This equipment must be installed and operated in compliance with local laws and regulations.
- Ensure that the ambient temperature at the installation is between 5°C (41°F) and 35°C (95°F). If the temperature at the site is not actively regulated, ensure that daily and seasonal temperature changes will not result in the ambient temperature going outside these limits.
- Always fully stabilize racks with wall anchors or stabilizing legs, or both, before mounting the Nexsan storage unit or any other components on the rack.
- Situate the rack so that full air flow at both the front and the rear of the Nexsan storage system is possible.
- Ensure that the floor beneath the mounting rack has enough load-bearing capacity to support the rack and all mounted components.
- Always fully secure all rack-mounting hardware when installing the Nexsan storage system in a rack. Insufficient rack-mount support may allow the unit to fall onto other rack-mounted hardware or onto the floor, potentially damaging equipment or causing injury to nearby personnel.

Rack and enclosure specifications

Rail kit mounting

- 4U enclosure height
- The rack must have square roles
- Maximum distances: 30" (800 mm)

Enclosure weight and dimensions

- Height: 6.88" 174 mm
- Width: 17.72" 450 mm
- Depth: 35.43" 900 mm
72" 1830 mm (extended)
- Weight: 83.9 lbs 38.4 kg (no drives installed)
175 lbs 79.4 kg (all drives installed)

Power requirements

- Power supply: 1,600W
- Input voltage: 200-240V
- Power consumption: varies depending on the number and size of drives, running fans, and room temperature

NEXSAN

Part number: P0450181 Rev: B Release Date: September 2021

Related Documentation: Nexsan Unity Hardware Maintenance Guide, Nexsan Unity Software User Guide, Nexsan Unity Online Help, Nexsan Unity nxadmin CLI Reference Guide

Technical Support

By Email: support@nexsan.com

By Web: <https://www.nexsan.com/support/support-unity/>

Copyright © 2010-2021 Nexsan Technologies, Inc. All Rights Reserved. Nexsan®, Unity™, Unity 3300™, Unity 7900™, and FASTier™, and the Nexsan logo are trademarks or registered trademarks of Nexsan Technologies, Inc. All other trademarks and registered trademarks are the property of their respective owners.